

# Operation Guide 5463

CASIO®

Congratulations upon your selection of this CASIO watch.

ENGLISH

## Applications

The built-in sensors of this watch measure direction, barometric pressure, temperature and altitude. Measured values are then shown on the display. Such features make this watch useful when hiking, mountain climbing, or when engaging in other such outdoor activities.

### Warning !

- The measurement functions built into this watch are not intended for taking measurements that require professional or industrial precision. Values produced by this watch should be considered as reasonable representations only.
- When engaging in mountain climbing or other activities in which losing your way can create a dangerous or life-threatening situation, always use a second compass to confirm direction readings.
- Note that CASIO COMPUTER CO., LTD. assumes no responsibility for any damage or loss suffered by you or any third party arising through the use of your watch or its malfunction.

## Important!

- The watch's Altimeter Mode calculates and displays relative altitude based on barometric pressure readings produced by its pressure sensor. This means that readings taken at different times at the same location may produce different altitude values due to changes in barometric pressure. Also note that the value displayed by the watch may be different from the actual elevation and/or sea level elevation indicated for the area where you are located.
- When using the watch's altimeter while mountain climbing, be sure to perform regular calibration in accordance with the local altitude (elevation) indications. For more information, see "To specify a reference altitude value" (page E-56).
- Whenever you use the digital compass of this watch for serious trekking, mountain climbing, or other activities, be sure always to take along another compass to confirm readings. If the readings produced by the digital compass of this watch are different from those of the other compass, perform bidirectional calibration of the digital compass to ensure more accurate readings.
- Direction readings and digital compass calibration will not be possible if the watch is in the vicinity of a permanent magnet (magnetic accessory, etc.), metal objects, high-voltage wires, aerial wires, or electrical household appliances (TV, computer, cellphone, etc.).

E

B

E-1

## About This Manual

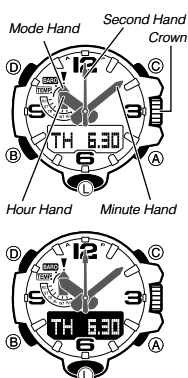

- Depending on the model of your watch, digital display text appears either as dark figures on a light background, or light figures on a dark background. All examples in this manual are shown using dark figures on a light background.
- Button operations are indicated using the letters shown in the illustration.
- Note that the product illustrations in this manual are intended for reference only, and so the actual product may appear somewhat different than depicted by an illustration.

E-2

## Using the Crown

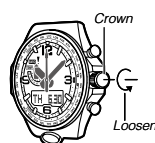

The crown of this watch is a screw in lock crown. Before using the crown, you must first rotate it towards you to loosen it. After performing crown operations, be sure to press the crown in lightly as you screw it back in.

### Important!

- To maintain water resistance and avoid impact damage to the crown, be sure to screw it back in when you are not using it.

The illustrations below show the different crown operations.

Pull out	Rotate	Push in

E-3

## High-speed Movement

You can use either of the crown operations described below to move watch hands or indicators at high speed.

HS1: Can be used to move both hands and display indicators.

HS2: Can be used when setting the hour and minute manually to move the hands at high speed.

### To start HS1 high-speed movement

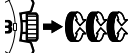

While the crown is pulled out, rotate it rapidly three turns away from you (for forward movement) or towards you (for reverse movement). High-speed movement will continue even if you release the crown.

### To start HS2 high-speed movement

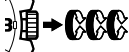

While the HS1 high-speed movement is in progress, again rotate the crown rapidly three turns in the same direction as the current HS1 movement (away from you for forward movement or towards you for reverse movement).

## To stop high-speed movement



Rotate the crown in the direction that is opposite that of the current high-speed movement or press any button.

## Note

- If you do not perform any operation for more than two minutes after pulling out the crown, the indicator shown below will appear and crown operations will become disabled. If this happens, push the crown back in and then pull it out again to re-enable crown operations.
- Pulling out the crown while the watch is in a mode that does not allow configuration of any settings will cause the indicator shown below to appear. If this happens, push the crown back in and lock it.
- The indicator shown below also appears when performing hand home position adjustment. See "Hand Home Position Adjustment" (page E-39) for more information.

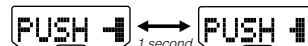

- You can use high-speed movement in the following cases: when changing the time and/or date setting in the Timekeeping Mode, World Time Mode, Countdown Timer Mode, or Alarm Mode, or when performing magnetic declination angle calibration, altitude calibration, barometric pressure calibration, or temperature calibration operations.

E-4

E-5

## Things to check before using the watch

### 1. Check the battery power level.

Hold down **(D)** for at least two seconds to enter the Timekeeping Mode and display the battery power level.

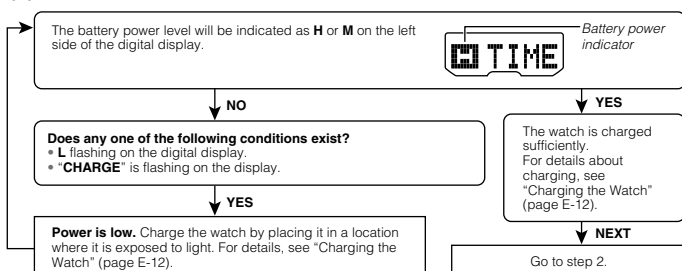

- When L is flashing, the second hand will jump at two-second intervals.
- When CHARGE is flashing, all hands will move to and stop at 12 o'clock.

E-6

### 2. Check the Home City and the daylight saving time (DST) setting.

Use the procedure under "To configure Home City and summer time settings" (page E-34) to configure your Home City and daylight saving time settings.

### Important!

Proper time calibration signal reception, and World Time Mode data depend on correct Home City, time, and date settings in the Timekeeping Mode. Make sure you configure these settings correctly.

### 3. Set the current time.

- To set the time using a time calibration signal  
See "To get ready for a receive operation" (page E-21).
- To set the time manually  
See "Configuring Current Time and Date Settings Manually" (page E-36).

### The watch is now ready for use.

- For details about the watch's radio controlled timekeeping feature, see "Radio Controlled Atomic Timekeeping" (page E-19).

E-7

## Contents

<b>About This Manual</b> .....	<b>E-2</b>
<b>Using the Crown</b> .....	<b>E-3</b>
<b>Things to check before using the watch</b> .....	<b>E-6</b>
<b>Charging the Watch</b> .....	<b>E-12</b>
To recover from the sleep state .....	E-18
<b>Radio Controlled Atomic Timekeeping</b> .....	<b>E-19</b>
To get ready for a receive operation .....	E-21
To perform manual receive .....	E-23
To check the latest signal reception results .....	E-26
To turn auto receive on or off .....	E-27
<b>Mode Reference Guide</b> .....	<b>E-29</b>
<b>Timekeeping</b> .....	<b>E-33</b>
<b>Configuring Home City Settings</b> .....	<b>E-34</b>
To configure Home City and summer time settings .....	E-34
<b>Configuring Current Time and Date Settings Manually</b> .....	<b>E-36</b>
To change the current time and date settings manually .....	E-36
To switch between 12-hour and 24-hour timekeeping.....	E-38
<b>Hand Home Position Adjustment</b> .....	<b>E-39</b>
To adjust home positions .....	E-39

E-8

<b>Taking Temperature Readings</b> .....	<b>E-77</b>
To take temperature readings .....	E-77
To calibrate the temperature sensor .....	E-78
<b>Viewing Altitude Records</b> .....	<b>E-80</b>
To view altitude records .....	E-80
To delete all recorded data .....	E-83
To delete a specific record .....	E-83
<b>Using the Stopwatch</b> .....	<b>E-84</b>
To enter the Stopwatch Mode .....	E-84
To perform an elapsed time operation .....	E-84
To pause at a split time.....	E-84
To measure two finishes .....	E-85
<b>Using the Countdown Timer</b> .....	<b>E-86</b>
To enter the Countdown Timer Mode.....	E-86
To specify the countdown start time .....	E-86
To perform a countdown timer operation .....	E-87
To stop the alarm .....	E-87
<b>Using the Alarm</b> .....	<b>E-88</b>
To enter the Alarm Mode .....	E-88
To set an alarm time .....	E-89
To turn an alarm and the Hourly Time Signal on and off.....	E-90
To stop the alarm .....	E-90
To test the alarm .....	E-90

E-10

<b>Moving the Hands for Easy Viewing of the Digital Dials</b> .....	<b>E-40</b>
To shift the hands and view digital info .....	E-40
To return the hands to their normal positions .....	E-41
<b>Taking Direction Readings</b> .....	<b>E-42</b>
To take a direction reading .....	E-43
To perform bidirectional calibration.....	E-47
To perform magnetic declination correction .....	E-48
<b>Specifying Altitude, Barometric Pressure, and Temperature Units</b> .....	<b>E-51</b>
To specify altitude, barometric pressure, and temperature units .....	E-51
<b>Using the Altimeter Mode</b> .....	<b>E-52</b>
To specify the altitude auto reading interval .....	E-53
To take altitude readings .....	E-54
To specify a reference altitude value .....	E-56
To specify the altitude differential measurement range .....	E-58
To use the altitude differential value .....	E-59
To save a reading manually.....	E-61
<b>Precautions Concerning Simultaneous Altitude and Temperature Readings</b> .....	<b>E-67</b>
<b>Taking Barometric Pressure Readings</b> .....	<b>E-68</b>
To take barometric pressure readings .....	E-68
To show and hide barometric pressure differential .....	E-71
To enable or disable the barometric pressure change indicator .....	E-74
To calibrate the pressure sensor.....	E-76
	E-9

<b>Checking the Current Time in a Different Time Zone</b> .....	<b>E-91</b>
To enter the World Time Mode .....	E-91
To configure World Time City and summer time settings .....	E-92
To swap your Home City and World Time City .....	E-94
To access the UTC (Universal Time Coordinated) time zone .....	E-94
<b>Illumination</b> .....	<b>E-95</b>
To turn on illumination manually .....	E-95
To change the illumination duration .....	E-95
To enable or disable the auto light switch .....	E-97
<b>Other Settings</b> .....	<b>E-99</b>
To turn the button operation tone on or off .....	E-99
To turn Power Saving on or off .....	E-99
<b>Troubleshooting</b> .....	<b>E-100</b>
<b>Specifications</b> .....	<b>E-107</b>

E-11

## Charging the Watch

The face of the watch is a solar panel that generates power from light. The generated power charges a built-in rechargeable battery, which powers watch operations. The watch charges whenever it is exposed to light.

### Charging Guide

Whenever you are not wearing the watch, leave it in a location where it is exposed to light.

- Best charging performance is achieved by exposing the watch to the strongest light available.



When wearing the watch, make sure that its face is not blocked from light by the sleeve of your clothing.

- The watch may enter a sleep state (page E-18) if its face is blocked by your sleeve even only partially.

### Warning!

Leaving the watch in bright light for charging can cause it to become quite hot. Take care when handling the watch to avoid burn injury. The watch can become particularly hot when exposed to the following conditions for long periods.

- On the dashboard of a car parked in direct sunlight
- Too close to an incandescent lamp
- Under direct sunlight

E-12

### Important!

- Allowing the watch to become very hot can cause its liquid crystal display to go blank (totally black or totally white, depending on the watch model). The appearance of the LCD should become normal again when the watch returns to a lower temperature.
- Turn on the watch's Power Saving function (page E-18) and keep it in an area normally exposed to bright light when storing it for long periods. This helps to ensure that power does not run down.
- Storing the watch for long periods in an area where there is no light or wearing it in such a way that it is blocked from exposure to light can cause power to run down. Expose the watch to bright light whenever possible.

### Power Levels

Hold down (B) for at least two seconds to enter the Timekeeping Mode.

You can get an idea of the watch's power level by observing the battery power indicator on the display.

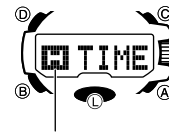

Battery power indicator

Level	Battery Power Indicator	Function Status
1 (H)		All functions enabled.
2 (M)		All functions enabled.

Level	Battery Power Indicator	Function Status
3 (L)		Auto and manual receive, illumination, beeper, and sensor operation disabled. Second hand jumps every two seconds.
4 (CHARGE)		All hands stopped at 12 o'clock. All functions disabled.
5	---	All hands stopped at 12 o'clock. All functions disabled and settings return to their initial factory defaults.

- The flashing L indicator at Level 3 (L) tells you that battery power is very low, and that exposure to bright light for charging is required as soon as possible.
- Once the battery reaches Level 2 (M) after falling to Level 5, reconfigure the current time, date, and other settings.
- Display indicators reappear as soon as the battery is charged from Level 5 to Level 2 (M).
- Leaving the watch exposed to direct sunlight or some other very strong light source can cause the battery power indicator to show a reading temporarily that is higher than the actual battery level. The correct battery level should be indicated after a few minutes.

E-14

- All data stored in memory is deleted, and the current time and all other settings return to their initial factory defaults whenever battery power drops to Level 5 and when you have the battery replaced. A dark environment while battery power is at Level 4 will cause the level to drop to Level 5. Expose the watch to bright light whenever possible.

Jumps at two-second intervals

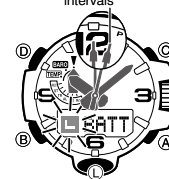

### Low battery alert

When battery power reaches Level 3, the second hand of the watch will jump at 2-second intervals in the Timekeeping Mode to let you know that charging is required.

E-13

E-15

## Power Recovery Mode

- Performing multiple sensor, illumination, or beeper operations during a short period may cause the recovery indicator (**RECOVER**) to start flashing on the display. This indicates that the watch is in the power recovery mode. Illumination, alarm, countdown timer alarm, hourly time signal, and sensor operations will be disabled until battery power recovers.
- Battery power will recover in about 15 minutes. At this time, the recovery indicator (**RECOVER**) will stop flashing. This indicates that the functions listed above are enabled again.
- Frequent flashing of the recovery indicator (**RECOVER**) indicates that battery power is low. Expose the watch to bright light as soon as possible.
- Even if battery power is at Level 1 (**H**) or Level 2 (**M**), the Digital Compass Mode, Barometer Mode, Thermometer Mode or Altimeter Mode sensor may be disabled if there is not enough power available to power it sufficiently. This is indicated when the recovery indicator (**RECOVER**) are flashing.
- Frequent flashing of the recovery indicator (**RECOVER**) probably means that remaining battery power is low. Leave the watch in bright light to allow it to charge.

E-16

## Charging Times

Exposure Level (Brightness)	Daily Operation <sup>*1</sup>	Level Change <sup>*2</sup>				
		Level 5	Level 4	Level 3	Level 2	Level 1
Outdoor sunlight (50,000 lux)	8 min.	3 hours			23 hours	6 hours
Sunlight through a window (10,000 lux)	30 min.	7 hours			85 hours	23 hours
Daylight through a window on a cloudy day (5,000 lux)	48 min.	10 hours			137 hours	37 hours
Indoor fluorescent lighting (500 lux)	8 hours	121 hours			---	---

<sup>\*1</sup> Approximate amount of exposure time required each day to generate enough power for normal daily operation.

<sup>\*2</sup> Approximate amount of exposure time (in hours) required to take power from one level to the next.

- The above exposure times all are for reference only. Actual exposure times depend on lighting conditions.

• For details about the operating time and daily operating conditions, see the "Power Supply" section of the Specifications (page E-110).

E-17

## Power Saving

When turned on, Power Saving enters a sleep state automatically whenever the watch is left for a certain period in an area where it is dark. The table below shows how watch functions are affected by Power Saving.

- For information about enabling and disabling power saving, see "To turn Power Saving on or off" (page E-99).
- There actually are two sleep state levels: "display sleep" and "function sleep".

Elapsed Time in Dark	Hands and Display	Operation
60 to 70 minutes (display sleep)	Blank display, second hand stopped.	Except for display and second hand, all functions enabled.
6 or 7 days (function sleep)	Blank display, all hands stopped at 12 o'clock.	Except for timekeeping, all functions disabled.

- The watch will not enter a sleep state between 6:00 AM and 9:59 PM. If the watch is already in a sleep state when 6:00 AM arrives, however, it will remain in the sleep state.
- The watch will not enter a sleep state while it is in the Stopwatch Mode or Countdown Timer Mode.
- The watch will not enter a sleep state while barometric pressure change indicator is enabled (page E-73).

### To recover from the sleep state

Move the watch to a well-lit area, press any button, or angle the watch towards your face for reading (page E-96).

E-18

## Radio Controlled Atomic Timekeeping

This watch receives a time calibration signal and updates its time setting accordingly. However, when using the watch outside of areas covered by time calibration signals, you will have to adjust the settings manually as required. See "Configuring Current Time and Date Settings Manually" (page E-36) for more information.

This section explains how the watch updates its time settings when the city code selected as the Home City is in Japan, North America, Europe, or China, and is one that supports time calibration signal reception.

If your Home City Code setting is this:	The watch can receive the signal from the transmitter located here:
LONDON (LON), PARIS (PAR), ATHENS (ATH)	Anthorn (England), Mainflingen (Germany)
HONG KONG (HKG)	Shangqiu City (China)
TOKYO (TYO)	Fukushima, Fukuoka/Saga (Japan)
NEW YORK (NYC), CHICAGO (CHI), DENVER (DEN), LOS ANGELES (LAX), ANCHORAGE (ANC), HONOLULU (HNL)	Fort Collins, Colorado (United States)

### Important!

- The areas covered by **ANC** and **HNL** are quite far from the calibration signal transmitters, so certain conditions may cause reception problems.

E-19

## Approximate Reception Ranges

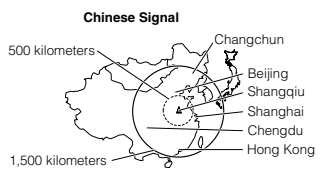
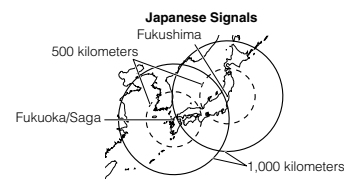
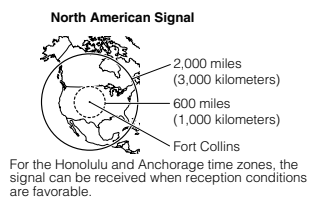
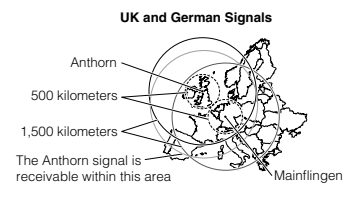

E-20

- Even when the watch is within range of a transmitter, signal reception may be impossible due to the effects of geographic contours, structures, weather, the time of year, the time of day, radio interference, etc. The signal becomes weaker at distances of approximately 500 kilometers, which means that the influence of the conditions listed above becomes even greater.
- Signal reception may not be possible at the distances noted below during certain times of the year or day. Radio interference may also cause problems with reception.
- Mainflingen (Germany) or Anthorn (England) transmitters: 500 kilometers (310 miles)
- Fort Collins (United States) transmitter: 600 miles (1,000 kilometers)
- Fukushima or Fukuoka/Saga (Japan) transmitters: 500 kilometers (310 miles)
- Shangqiu (China) transmitter: 500 kilometers (310 miles)
- As of December 2014, China does not use Daylight Saving Time (DST). If China does go to the Daylight Saving Time system in the future, some functions of this watch may no longer operate correctly.

### To get ready for a receive operation

1. Confirm that the watch is in the Timekeeping Mode. If it isn't, use **Ⓟ** to enter the Timekeeping Mode (page E-30).
2. The antenna of this watch is located on its 12 o'clock side. Position the watch with 12 o'clock facing towards a window as shown in the nearby illustration. Make sure there are no metal objects nearby.

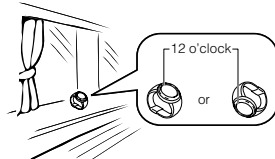

E-21

- Signal reception may be difficult or even impossible under the conditions described below.



### 3. What you should do next depends on whether you are using auto receive or manual receive.

- Auto receive: Leave the watch over night in the location you selected in step 2. See "Auto Receive" below for details.
- Manual receive: Perform the operation under "To perform manual receive" on page E-23.

### Auto Receive

- With auto receive, the watch performs the receive operation each day automatically up to six times (up to five times for the Chinese calibration signal) between the hours of midnight and 5 a.m. (according to the Timekeeping Mode time). When any receive operation is successful, none of the other receive operations for that day are performed.
- When a calibration time is reached, the watch will perform the receive operation only if it is in the Timekeeping Mode. The receive operation is not performed if a calibration time is reached while you are configuring settings.

E-22

- You can use the procedure under "To turn auto receive on and off" (page E-27) to enable or disable auto receive.

### To perform manual receive

1. Use **Ⓟ** to enter the Receive Mode (**R/C**) as shown on page E-30.

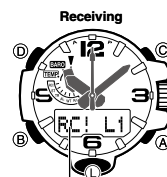

2. Hold down **Ⓟ** for at least two seconds until **RC** flashes and then **RC!** appears on the digital display.
  - A signal level indicator (**L1**, **L2**, or **L3**, see page E-25) will appear on the display after reception starts. Do not allow the watch to move and do not perform any button operation until **GET** or **ERR** appears on the display.
  - If the receive operation is successful, the reception date and time appear on the display, along with the **GET** indicator.
  - The watch will immediately return to the Timekeeping Mode if you press any button, or if you do not perform any button operation for about two or three minutes.

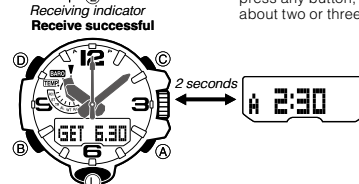

E-23

### Receive failed

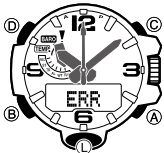

If there was a previously successful reception

E-24

### Signal Level Indicator

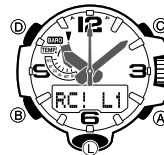

During calibration signal reception, the signal level indicator displays the signal level as shown below.



The level indication will change in accordance with reception conditions while reception is being performed.

- As you watch the indicator, keep the watch in a location that best maintains stable reception.
- Even under optimum reception conditions, it can take about 10 seconds for reception to stabilize.
- Note that weather, the time of day, surroundings, and other factors all can affect reception.

E-25

### To check the latest signal reception results

Enter the Receive Mode (page E-30).

1. **R/C** will be displayed for about one second, and then the date (month and day) and the time of the last signal reception will alternate on the digital display at two second intervals.
  - Dashes (- : - and - - -) alternating in place of the date and time indicate there has been no successful signal reception yet (since you purchased the watch or had its battery replaced).

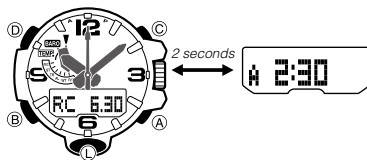

2. To return to the Timekeeping Mode, press **(B)**.

E-26

### To turn auto receive on or off

1. Enter the Receive Mode (page E-30).

1. **R/C** will be displayed for about one second, and then the date (month and day) and the time of the last signal reception will alternate on the digital display.
  - Dashes (- : - and - - -) alternating in place of the date and time indicate there has been no successful signal reception yet (since you purchased the watch or had its battery replaced).
2. Pull out the crown. This will cause the current auto receive status (**ON** or **OFF**) to flash on the digital display.
  - Only **AUTORC OFF** is displayed for cities that do not support time calibration signal reception.
  - **AUTORC ON** is not displayed.
3. Rotate the crown to select either auto receive on (**ON**) or auto receive off (**OFF**).
4. After the setting is the way you want, push the crown back in. This will return to the screen that was displayed in step 1 of this procedure.

### Radio-controlled Atomic Timekeeping Precautions

- Strong electrostatic charge can result in the wrong time setting.
- Even if a receive operation is successful, certain conditions can cause the time setting to be off by up to one second.
- The watch is designed to update the date and day of the week automatically for the period January 1, 2000 to December 31, 2099. Updating of the date by signal reception will no longer be performed starting from January 1, 2100.
- If you are in an area where signal reception is not possible, the watch keeps time with the precision noted in "Specifications".

E-27

• The receive operation is disabled under any of the following conditions.

- While power is at Level 3 (L) or lower (page E-14)
- While the watch is in the power recovery mode (page E-16)
- While a direction, barometric pressure, temperature, or altitude reading operation is in progress
- When the watch is in the function sleep state ("Power Saving", page E-18)
- While barometric pressure change indicator is being measured
- While a countdown timer operation is in progress (page E-86)
- A receive operation is cancelled if an alarm sounds while it is being performed.
- The Home City setting reverts to the initial default of **TYO** (Tokyo) whenever the battery power level drops to Level 5 or when you have the rechargeable battery replaced. If this happens, change the Home City to the setting you want (page E-34).

E-28

### Mode Reference Guide

Your watch has 11 "modes". The mode you should select depends on what you want to do.

To do this:	Enter this mode:	See:
<ul style="list-style-type: none"> <li>• View the current time and date in the Home City</li> <li>• Configure Home City and daylight saving time (DST) settings</li> <li>• Configure time and date settings manually</li> <li>• Enable auto signal reception</li> </ul>	Timekeeping Mode	E-33
Determine your current bearing or the direction from your current location to a destination	Digital Compass Mode	E-42
<ul style="list-style-type: none"> <li>• View the altitude at your current location</li> <li>• Determine the altitude differential between two locations (reference point and current location)</li> <li>• Record an altitude reading with the reading time and date</li> </ul>	Altimeter Mode	E-52
<ul style="list-style-type: none"> <li>• View the barometric pressure at your current location</li> <li>• View a graph of barometric pressure readings</li> <li>• Enable alerts (display and beep) for noteworthy changes in barometric pressure</li> </ul>	Barometer Mode	E-68
View the temperature at your current location	Thermometer Mode	E-77
Recall records created in the Altimeter Mode	Data Recall Mode	E-80
Use the stopwatch to measure elapsed time	Stopwatch Mode	E-84
Use the countdown timer	Countdown Timer Mode	E-86
Set an alarm time	Alarm Mode	E-88
View the current time in 29 cities (29 time zones) and UTC (Universal Coordinated Time) time	World Time Mode	E-91
<ul style="list-style-type: none"> <li>• Perform a manual time calibration signal receive operation</li> <li>• Check whether the last receive operation was successful</li> <li>• Configure auto receive settings</li> </ul>	Receive Mode	E-19

E-29

### Selecting a Mode

- The illustration below shows which buttons you need to press to navigate between modes.
- To return to the Timekeeping Mode from any other mode, hold down **(B)** for about two seconds.

- Button operations are provided for direct access to the Timekeeping, Digital Compass, and Altimeter modes.

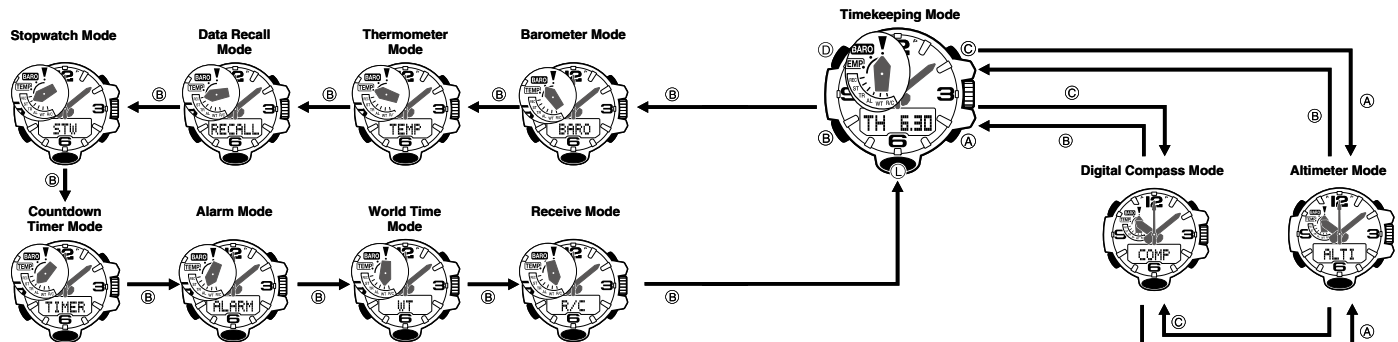

E-30

E-31

## General Functions (All Modes)

The functions and operations described in this section can be used in all of the modes.

### Auto Return Features

- The watch automatically returns to the Timekeeping Mode from other modes if the crown is not pulled out or if no button operation is performed for a preset amount of time.

Mode Name	Approximate Elapsed Time
Digital Compass	1 minute
Data Recall, Alarm, Receive	3 minutes
Altimeter	1 hour minimum 12 hours maximum
Barometer, Thermometer	1 hour

### Initial Screens

When you enter the Data Recall, Alarm, or World Time Mode, the data you were viewing when you last exited the mode appears first.

E-32

## Timekeeping

Use the Timekeeping Mode (TIME) to set and view the current time and date.

- Each press of (D) in the Timekeeping Mode will change screen contents as shown below.

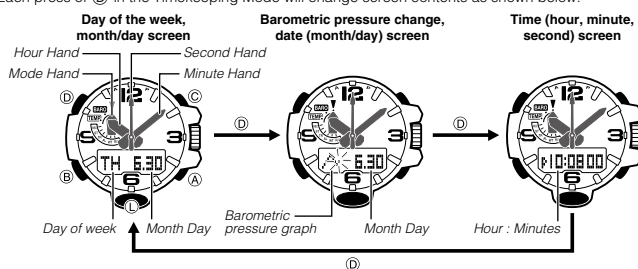

E-33

## Configuring Home City Settings

There are two Home City settings: actually selecting the Home City and selecting either standard time or daylight saving time (DST).

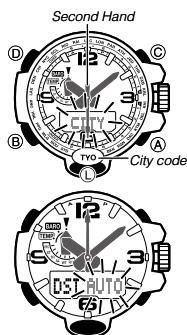

### To configure Home City and summer time settings

- In the Timekeeping Mode, pull out the crown.
  - CITY** will flash on the digital display indicating that the Home City setting can be changed.
  - For details about city codes, see the "City Code Table" at the back of this manual.
- Rotate the crown to move the second hand to the city code of the city you want you use as your Home City.
- Press (B) to display the DST setting screen.
- Rotate the crown away from you to cycle through the DST settings as shown below.

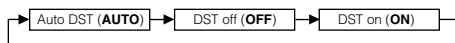

- The Auto DST (**AUTO**) setting will be available only when a city code that supports time calibration signal reception (page E-19) is selected as the Home City. While Auto DST is selected the DST setting will be changed automatically in accordance with time calibration signal data.
- Note that you cannot switch between standard time and daylight saving time (DST) while UTC is selected as your Home City.

- After the settings are the way you want, push the crown back in.
  - Daylight Saving Time is turned on when the **DST** indicator is on the display.

### Note

- After you specify a city code, the watch will use UTC\* offsets in the World Time Mode to calculate the current time for other time zones based on the current time in your Home City.
  - \* Coordinated Universal Time, the world-wide scientific standard of timekeeping. The reference point for UTC is Greenwich, England.
- Selecting some city codes automatically makes it possible for the watch to receive the time calibration signal for the corresponding area. See page E-19 for details.

E-34

E-35

## Configuring Current Time and Date Settings Manually

You can configure current time and date settings manually when the watch is unable to receive a time calibration signal.

### To change the current time and date settings manually

- In the Timekeeping Mode, pull out the crown. This will cause **CITY** to flash on the digital display.
- Press (D).
  - This will cause **HOUR-MIN** to flash on the digital display.
  - The second hand will point to either **A** (a.m.) or **P** (p.m.)
  - This is the time setting mode.
  - In the following steps, each press of (B) cycles between settings as shown below.

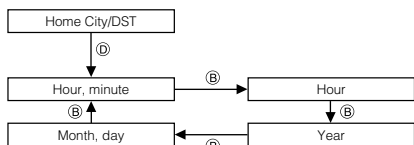

- Rotate the crown to change the minute setting.
- Press (B).
  - This will cause **HOUR** to flash on the digital display.
- Rotate the crown to change the hour setting.
- Press (B).
  - This causes the currently set year, month, and day to appear on the digital display, with the year setting flashing.
- Rotate the crown to adjust the year setting.
- Press (B).
  - This causes the currently set date (month, day) setting to flash on the display.
- Rotate the crown to adjust the month and day setting.
  - Pressing (B) will return to the hour and minute setting screen.
- After the settings are the way you want, push the crown back in.
  - This will cause timekeeping to start from 0 seconds.

E-36

E-37

### Note

- For information about selecting a Home City and configuring the DST setting, see "Configuring Home City Settings" (page E-34).
- While 12-hour timekeeping is in use, **P** (p.m.) is displayed from noon to midnight (11:59 p.m.) **A** (a.m.) is displayed from midnight to noon (11:59 a.m.) These indicators are not displayed while 24-hour timekeeping (displays times from 00:00 to 23:59) is being used.
- The watch's built-in full automatic calendar makes allowances for different month lengths and leap years. Once you set the date, there should be no reason to change it except after you have the watch's rechargeable battery replaced or after power drops to Level 5 (page E-14).
- The day of the week changes automatically when the date changes.

### To switch between 12-hour and 24-hour timekeeping

- Pull out the crown.
- Press (B) five times.
  - This causes the current timekeeping setting (**12H** or **24H**) to flash on the digital display.
- Rotate the crown to select either 12-hour (**12H**) or 24-hour (**24H**) timekeeping.
- After the setting is the way you want, push the crown back in.

## Hand Home Position Adjustment

If the watch is exposed to strong magnetism or impact, its hands can go out of alignment with the time on the digital display. This can result in incorrect time indication even though a time calibration signal is being received. The watch has a function to correct hand position automatically as required.

### To adjust home positions

Wait until all of the hands move to 12 o'clock.



- In the Timekeeping Mode, pull out the crown.
- Hold down (A) for at least five seconds until **HAND SET** flashes and then **HAND ADJ** appears on the digital display.
  - This indicates the hand home position adjustment mode.
- Push the crown back in.
  - This will cause all of the hands (mode, hour, minute, second) to return to their normal positions.

### Note

After performing home position adjustment, enter the Timekeeping Mode and check to make sure that the analog hands and the display indicate the same time. If they do not, perform home position adjustment again.

E-38

E-39



## Moving the Hands for Easy Viewing of the Digital Dials

You can use the procedure below to move the analog hands in order to better view a digital dial.

### Note

- The analog hands will not move while battery power is low.

### To shift the hands and view digital info

While holding down **L**, press **B**.

- This will cause all hands to move to 2 o'clock.

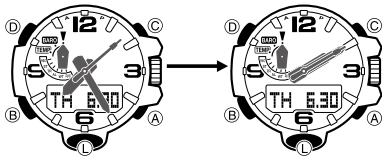

E-40

### To return the hands to their normal positions

Press any one of the following buttons: **A**, **B**, **C**, or **D**.

### Note

- The hands will also return to their normal positions if you do not perform any operation for about 10 seconds.
- If the hands have moved to 2 o'clock because you pulled out the crown,\* they will return to their normal positions when you push the crown back in.
- In this case, the hands will return to normal timekeeping when you push the crown back in.
- \* The hands will not move to 2 o'clock if you pull out the crown while configuring the city code setting (pages E-34, E-92) or the summer time setting (pages E-34, E-92), or while manually configuring time and date settings (page E-36).

### Auto Hand Shift

If the hour hand and/or minute hand is over the digital display when a displayed altitude, barometric pressure, or temperature reading is updated, the hand(s) will shift automatically (to 4 o'clock or 8 o'clock) and provide a better view of the information on the display. The hands will return to their normal position after about three seconds.

E-41

## Taking Direction Readings

You can use the Digital Compass Mode to determine the direction of north, and to check your bearing to a destination.

- For information about what you can do to improve digital compass reading accuracy, see "Calibrating the Bearing Sensor" (page E-45) and "Digital Compass Precautions" (page E-49).

### To take a direction reading

- Make sure the watch is in the Timekeeping, Digital Compass, or Altimeter Mode.
- Place the watch on a flat surface. If you are wearing the watch, make sure that your wrist is horizontal (in relation to the horizon).
- Point the 12 o'clock position of the watch in the direction whose reading you want to take.
- Press **C** to start.
  - COMP** will appear in the display to indicate that a digital compass operation is in progress.
  - Starting a digital compass operation will cause the second hand to move momentarily to the 12 o'clock position. After that, it will indicate magnetic north.

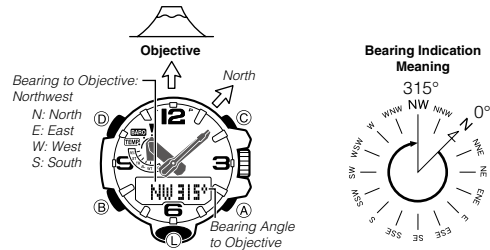

E-42

### Note

- The watch will return to the Timekeeping Mode about 60 seconds after the direction reading operation is complete.
- To restart a reading operation from the beginning, press **C**.
- Pressing **B** will return to the Timekeeping Mode even if a reading operation is in progress.

### Important!

- If the second hand does not point exactly at 12 o'clock after you perform step 4 above, perform the operation under "Hand Home Position Adjustment" (page E-39) to adjust it.
- If the digital display contents start to flash after you perform a reading operation, it means that abnormal magnetism has been detected. Move away from any potential source of strong magnetism and try taking a reading again. If the problem occurs when you try again, continue to keep away from the source of strong magnetism, perform bidirectional calibration, and then try taking a reading again. For more information, refer to "To perform bidirectional calibration" (page E-47) and "Location" (page E-50).

### Digital Compass Readings

- After the first reading is obtained, the watch will continue to take digital compass readings automatically each second for up to 60 seconds. After that, the reading operation will stop automatically.
- The margin of error for the angle value and the direction indicator is  $\pm 11$  degrees while the watch is horizontal (in relation to the horizon). If the indicated direction is northwest (**NW**) and 315 degrees, for example, the actual direction can be anywhere from 304 to 326 degrees.
- Note that taking a direction reading while the watch is not horizontal (in relation to the horizon) can result in large direction reading error.
- You can calibrate the bearing sensor if you suspect the direction reading is incorrect.

E-44

- Any ongoing direction reading operation is paused temporarily while the watch is performing an alert operation (daily alarm, Hourly Time Signal, countdown timer alarm) or while illumination is turned on (by pressing **D**). The direction reading operation resumes for its remaining duration after the operation that caused it to pause is finished.

### Calibrating the Bearing Sensor

You should calibrate the bearing sensor whenever you feel that the direction readings being produced by the watch are off. You can use any one of two different bearing sensor calibration methods: bidirectional calibration or magnetic declination correction.

#### Bidirectional Calibration

Bidirectional calibration calibrates the bearing sensor in relation to magnetic north. Use bidirectional calibration when you want to take readings within an area exposed to magnetic force. This type of calibration should be used if the watch becomes magnetized for any reason.

### Important!

- To ensure correct direction readings by this watch, be sure to perform bidirectional calibration before using it. The watch may produce incorrect direction readings if you do not perform bidirectional calibration.

#### Magnetic Declination Correction

With magnetic declination correction, you input a magnetic declination angle (difference between magnetic north and true north), which allows the watch to indicate true north. You can perform this procedure when the magnetic declination angle is indicated on the map you are using. Note that you can input the declination angle in whole degree units only, so you may need to round off the value specified on the map. If your map indicates the declination angle as  $7.4^\circ$ , you should input  $7^\circ$ . In the case of  $7.6^\circ$  input  $8^\circ$ , for  $7.5^\circ$  you can input  $7^\circ$  or  $8^\circ$ .

E-43

### Precautions about bidirectional calibration

- You can use any two opposing directions for bidirectional calibration. You must, however, make sure that they are 180 degrees opposite each other. Remember that if you perform the procedure incorrectly, you will get wrong bearing sensor readings.
- Do not move the watch while calibration of either direction is in progress.
- You should perform bidirectional calibration in an environment that is the same as that where you plan to be taking direction readings. If you plan to take direction readings in an open field, for example, calibrate in an open field.

### To perform bidirectional calibration

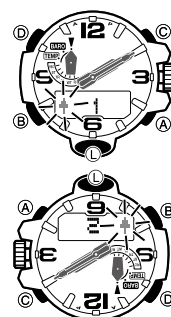

- In the Digital Compass Mode, pull out the crown.
  - This will cause **11** to appear on the digital display, with up arrow (**↑**) flashing.
- While keeping the watch horizontal, press **C**.
  - ↑ WAIT** will be shown on the digital display while calibration is in progress. **OK, Turn180°** will appear on the digital display if calibration is successful, and then **↑2** will appear.
  - If **ERR** appears on the display, press **C** again to restart the direction reading operation.
- Rotate the watch 180 degrees.
- Press **C** again to calibrate the second direction.
  - ↑ WAIT** is shown on the display while calibration is being performed.
  - When calibration is successful, the display will show **OK** and then change to the Digital Compass Mode screen.
- After calibration is complete, push the crown back in.

E-46

E-47

## To perform magnetic declination correction

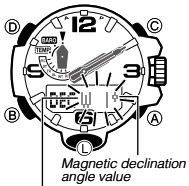

- In the Digital Compass Mode, pull out the crown.
  - This will cause **H1** to appear on the digital display, with up arrow (↑) flashing.
- Press **B**.
  - This will cause **DEC** and the current magnetic declination setting to appear on the digital display.
- Rotate the crown to change the magnetic declination direction and angle settings as desired.
  - The following explains magnetic declination angle direction settings.
    - OFF**: No magnetic declination correction performed. The magnetic declination angle with this setting is 0°.
    - E**: When magnetic north is to the east (east declination)
    - W**: When magnetic north is to the west (west declination)
  - You can select a value within the range of W 90° to E 90° with these settings.
  - You can turn off (**OFF**) magnetic declination correction by pressing **A** and **C** at the same time.
  - The illustration, for example, shows the value you should input and the direction setting you should select when the map shows a magnetic declination of 1° west.
- After calibration is complete, push the crown back in.

E-48

## Setting a map and finding your current location

Having an idea of your current location is important when mountain climbing or hiking. To do this, you need to "set the map", which means to align the map so the directions indicated on it are aligned with the actual directions of your location. Basically what you are doing is aligning north on the map with north as indicated by the watch.

- Note that map reading skills and experience are required to determine your current location and destination on a map.

### Digital Compass Precautions Magnetic North and True North

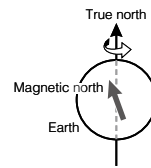

The northerly direction can be expressed either as magnetic north or true north, which are different from each other. Also, it is important to keep in mind that magnetic north moves over time.

- Magnetic north is the north that is indicated by the needle of a compass.
- True north, which is the location of the North Pole of the Earth's axis, is the north that is normally indicated on maps.
- The difference between magnetic north and true north is called the "declination". The closer you get to the North Pole, the greater the declination angle.

## Location

- Taking a direction reading when you are near a source of strong magnetism can cause large errors in readings. Because of this, you should avoid taking direction readings while in the vicinity of the following types of objects: permanent magnets (magnetic necklaces, etc.), concentrations of metal (metal doors, lockers, etc.), high tension wires, aerial wires, household appliances (TVs, personal computers, washing machines, freezers, etc.).
- Accurate readings are also impossible indoors, especially inside ferroconcrete structures. This is because the metal framework of such structures picks up magnetism from appliances, etc.
- Accurate direction readings are impossible while in a train, boat, air plane, etc.

## Storage

- The precision of the bearing sensor may deteriorate if the watch becomes magnetized. Because of this, you should store the watch away from magnets or any other sources of strong magnetism, including: permanent magnets (magnetic necklaces, etc.), concentrations of metal (metal doors, lockers, etc.), and household appliances (TVs, personal computers, washing machines, freezers, etc.).
- Whenever you suspect that the watch may have become magnetized, perform the procedure under "To perform bidirectional calibration" (page E-47).

E-50

## Specifying Altitude, Barometric Pressure, and Temperature Units

Use the procedure below to specify the altitude, barometric pressure, and temperature units to be used in the Altimeter Mode, Barometer Mode and the Thermometer Mode.



### Important!

- When **TYO** (Tokyo) is selected as the Home City, the altitude unit is set automatically to meters (**m**), the barometric pressure unit to hectopascals (**hPa**), and the temperature unit to Celsius (**°C**). These settings cannot be changed.

### To specify altitude, barometric pressure, and temperature units

- Make sure the watch is in the mode for the type of unit you want to specify (Altimeter, Barometer, or Thermometer Mode).
  - For information about changing modes, see "Selecting a Mode" (page E-30).
- Pull out the crown.
- Press **B** as many times as necessary until **UNIT** appear on the digital display.
  - For altitude, press **B** three times. For barometric pressure and temperature, press **B** once.
- Rotate the crown to change the unit setting.
- After the settings are the way you want, push the crown back in.

## Using the Altimeter Mode

The watch takes altitude readings and displays results based on air pressure measurements taken by a built-in pressure sensor. It also saves various types of altitude records and data.

- The displayed altitude reading is a relative altitude that is calculated based on measurement of changes in barometric pressure by the watch's pressure sensor. This means that barometric pressure changes can cause readings taken at different times at the same location to be different. Also note that the value displayed by the watch may be different from the actual elevation and/or sea level elevation indicated for the area where you are located. When using the watch's altimeter while mountain climbing, it is recommended that you perform regular calibration in accordance with the local altitude (elevation) indications.

### Important!

- See "To specify a reference altitude value" (page E-56) and "Altimeter Precautions" (page E-66) for information about how to minimize differences between readings produced by the watch and values provided by local altitude (elevation) indications.

### Getting Ready

Before actually taking an altitude reading you need to select an altitude reading interval.

#### Selecting the Altitude Auto Reading Interval

You can select either of the following two altitude auto reading interval.

- 0'05**: Readings at one-second intervals for the first three minutes, and then every five seconds for approximately the next hour
- 2'00**: Readings at one-second intervals for the first three minutes, and then every two minutes for approximately the next 12 hours

E-52

### Note

- If you do not perform any button operation while in the Altimeter Mode, the watch will return to the Timekeeping Mode automatically after 12 hours (altitude auto reading interval: **2'00**) or after one hour (altitude auto reading interval: **0'05**).

### To specify the altitude auto reading interval



- In the Altimeter Mode, pull out the crown.
  - This will cause the current altitude reading value to appear.
- Press **B**.
  - This will cause **INT** to appear on the digital display, along with the flashing current auto reading interval setting.
- Rotate the crown to select either five second (**0'05**) or two minutes (**2'00**) as the interval setting.
- After the setting is the way you want, push the crown back in to exit the setting screen.

### Taking Altitude Readings

Use the procedure below to take basic altitude readings.

- See "Using Reference Altitude Values" (page E-55) for information about how to make altimeter readings more accurate.
- See "How does the altimeter work?" (page E-65) for information about how the watch measures altitude.

## To take altitude readings

### Altitude Tendency Graph

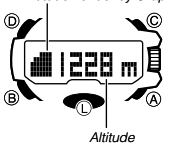

- Make sure the watch is in the Timekeeping, Digital Compass, or Altimeter Mode.
- Press **A** to start auto altimeter readings.
  - The current altitude value is displayed in units of 1 meter (5 feet).
  - For information about the measurement interval, see page E-52.

### Note

- When you press **A** above, the second hand may indicate seconds (of the current time) or the altitude differential (page E-57). The initial second hand function will be the same as what was selected the last time you took an altitude reading. To toggle between the two second hand functions (indicating seconds or indicating the altitude differential) press **D**.
- To restart a reading operation from the beginning, press **A**.
- After you are finished, press **B** to return to the Timekeeping Mode and stop auto altimeter readings.
- The watch will return to the Timekeeping Mode automatically if you do not perform any operation (page E-32).
- The measurement range for altitude is -700 to 10,000 meters (-2,300 to 32,800 feet).

- The displayed altitude value changes to - - - if an altitude reading falls outside the measurement range. An altitude value will reappear as soon as the altitude reading is within the allowable range.
- You can change the unit for displayed altitude values to either meters (m) or feet (ft). See "To specify altitude, barometric pressure, and temperature units" (page E-51).

E-54

- The altitude tendency graph shows changes in altitude over the past 6 readings while readings are being taken automatically.

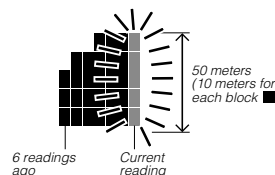

### Using Reference Altitude Values

To minimize the chance of reading error, you should update the reference altitude value before setting off on a trek or any other activity where you plan to take altitude readings. During a trek, keep checking the readings produced by the watch against altitude information provided by markers and other information, and update the reference altitude value as required.

- Reading error can be caused by changes in barometric pressure, atmospheric conditions, and elevation.
- Before performing the procedure below, look up the altitude of your current location on a map, the Internet, etc.

E-54

E-49

E-51

E-53

E-55

## To specify a reference altitude value

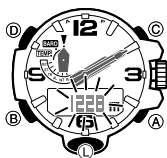

- In the Altimeter Mode, pull out the crown.
  - This will cause the current altitude reading value to flash on the digital display.
- Rotate the crown to change the altitude value in one-meter (five-foot) increments.
  - Change the reference altitude value to an accurate altitude reading that you get from a map or other source.
  - You can set the reference altitude value within the range of -3,000 to 10,000 meters (-9,840 to 32,800 feet).
  - Pressing (A) and (C) at the same time returns to **OFF** (no reference altitude value), so the watch performs air pressure to altitude conversions based on preset data only.
- After the setting is the way you want, push the crown back in to exit the setting screen.

E-56

## Advanced Altimeter Mode Operations

Use the information in this section to obtain more accurate altimeter readings, especially while mountain climbing or trekking.

### Using an Altitude Differential Value



If you specify a reference altitude, the second hand of the watch will indicate the difference between the current altitude and the reference altitude. The displayed altitude differential value is updated each time the watch obtains a new altitude reading value.

- Depending on the currently selected display range, the allowable range for the altitude differential value is 100 meters to -100 meters (100 meters = 328 feet), or 1,000 meters to -1,000 meters (1,000 meters = 3,280 feet).
- If a reading value is outside the allowable range either **OVER** (▲) or **UNDER** (▼) appears on the digital display.
- The second hand will move to 9 o'clock if a sensor reading could not be taken for some reason or if the reading is outside the allowable range.
- See "Using the Altitude Differential Value While Mountain Climbing or Hiking" (page E-58) for some real-life examples of how to use this feature.

E-57

## Specifying the Altitude Differential Measurement Range

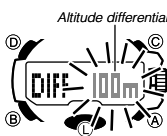

You can use the procedure below to select either  $\pm 100$  meters or  $\pm 1,000$  meters as the altitude differential measurement range.

Relative Altitude Measurement Range	Display Unit
$\pm 100$ meters ( $\pm 328$ feet)	5 meters (16 feet)
$\pm 1000$ meters ( $\pm 3280$ feet)	50 meters (164 feet)

### To specify the altitude differential measurement range

- In the Altimeter Mode, pull out the crown.
  - This will cause the current altitude reading value to appear.
- Press (B) twice.
  - This will cause **DIFF** to appear on the digital display, along with the flashing current altitude differential measurement range setting.
- Rotate the crown to select either 100 meters (**100m**) or 1,000 meters (**1000m**) as the altitude differential measurement range.
- After the setting is the way you want, push the crown back in to exit the setting screen.

## Using the Altitude Differential Value While Mountain Climbing or Hiking

After you specify the altitude differential start point while mountain climbing or hiking, you can easily measure the change in the altitude between that point and other points along the way.

## To use the altitude differential value

- In the Altimeter Mode, check to make sure that an altitude reading is on the display.
  - If an altitude reading is not displayed, press (A) to take one. See "To take altitude readings" (page E-54) for details.
- Use the contour lines on your map to determine the difference in altitude between your current location and your destination.
- In the Altimeter Mode, hold down (D) for at least two seconds to specify your current location as the altitude differential start point.
  - DIFF RESET** and then **RESET** will appear. The watch will take an altitude reading, and the second hand will indicate the altitude differential.  $\pm 0$  ( $\pm 0$  meters) will be displayed as the altitude differential at the reference point.
- While comparing the altitude difference you determined on the map and the watch's altitude differential value, advance towards your destination.
  - If the map shows that the difference in altitude between your location and your destination is +80 meters for example, you know you will be nearing your destination when the displayed altitude differential value shows +80 meters.

Altitude Differential (Reference location, so  $\pm 0$  m is indicated.)



Current altitude

E-58

E-59

The altitude differential with the reference location is indicated by the second hand (altitude differential indicator) as shown in the illustration below.

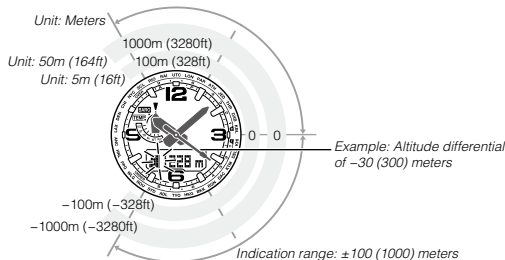

E-60

E-61

## Auto Save Values

Auto save values are one type of data stored in the memory of your watch.

Auto Save Values
High Altitude ( <b>MAX</b> )
Low Altitude ( <b>MIN</b> )
Total Ascent ( <b>ASC</b> )
Total Descent ( <b>DSC</b> )

- These values are checked and updated automatically by the watch as altitude auto measurements are taken.
- Auto save is performed only while the watch is in the Altimeter Mode.
- Cumulative ascent and cumulative descent values are updated whenever there is a difference of at least  $\pm 15$  meters ( $\pm 49$  feet) from one reading to the next.
- Auto save values also include the date and time each value was recorded.

## How High and Low Altitude Values are Updated

With each auto save reading, the watch compares the current reading against the **MAX** (high altitude) and **MIN** (low altitude) values. It will replace the **MAX** value if the current reading is at least 15 meters ( $\pm 49$  feet) greater than **MAX**, or the **MIN** value if the current reading is at least 15 meters ( $\pm 49$  feet) less than **MIN**.

## Types of Altitude Data

Your watch can record two types of altitude data in its memory: manually saved data and auto save values.

- Use the Data Recall Mode to view data stored in memory. See "Viewing Altitude Records" (page E-80) for details.

## Manually Saved Records

Any time you perform the procedure below in the Altimeter Mode, the watch will create and store a record with the currently displayed altitude reading, along with the date and time the reading was taken. There is enough memory to store up to 30 manually saved records, which are numbered from -01- through -30-.

### To save a reading manually



- In the Altimeter Mode, check to make sure that an altitude reading is on the display.
  - If an altitude reading is not displayed, press (A) to take one. See "To take altitude readings" (page E-54) for details.
- Hold down (A) until **REC** flashes and then stops flashing.
  - This will save the currently displayed altitude reading in a manually saved record, along with the time and date of the reading.
  - The watch will return to the Altimeter Mode screen automatically after the save operation is complete.
  - There is enough memory to store up to 30 manually saved records. If there are already 30 manually saved records in memory, the above operation will cause the oldest record to be deleted automatically to make room for the new one.

## How Cumulative Ascent and Cumulative Descent Values are Updated

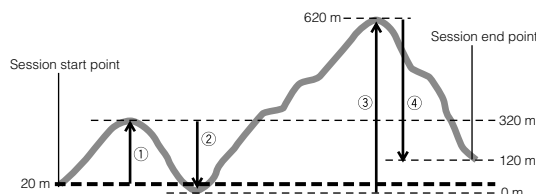

The total ascent and total descent values produced by an Altimeter Mode reading operation session during the example climb illustrated above are calculated as follows.

Total Ascent: ① (300 m) + ③ (620 m) = 920 m  
 Total Descent: ② (320 m) + ④ (500 m) = 820 m

E-62

E-63



- Entering the Altimeter Mode starts a new altitude auto reading session, but it does not reset the current **ASC** and **DSC** values or change them in any way. This means that the starting **ASC** and **DSC** values for a new Altimeter Mode auto reading session are the values that currently are in memory. Each time you complete an altitude auto reading session by exiting the Altimeter Mode, the total ascent value of the current session (920 meters in the above example) is added to the session's starting **ASC** value. Also, the total descent value of the current auto reading session (-820 meters in the above example) is added to the session's starting **DSC** value.

**Note**

- The high altitude, low altitude, total ascent, and total descent values are retained in memory when you exit the Altimeter Mode. To clear values, perform the procedure under "To delete a specific record" (page E-83).

**How does the altimeter work?**

Generally, air pressure decreases as altitude increases. This watch bases its altitude reading on International Standard Atmosphere (ISA) values stipulated by the International Civil Aviation Organization (ICAO). These values define relationships between altitude and air pressure.

- Note that the following conditions will prevent you from obtaining accurate readings:

*When air pressure changes because of changes in the weather*

*Extreme temperature changes*

*When the watch itself is subjected to strong impact*

There are two standard methods of expressing altitude: absolute altitude, which expresses an absolute height above sea level, and relative altitude, which expresses the difference between the altitudes of two different places. This watch expresses altitudes as relative altitude.

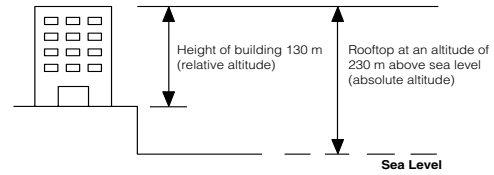

Regular calibration of the watch in accordance with values provided by local altitude (elevation) indications is recommended before taking readings in order to maximize reading accuracy (page E-55).

**Altimeter Precautions**

- This watch estimates altitude based on air pressure. This means that altitude readings for the same location may vary if air pressure changes.
- Do not use this watch for altitude reading or perform button operations while sky diving, hang gliding, or paragliding, while riding a gyrocopter, glider, or any other aircraft, or while engaging in any other activity where there is the chance of sudden altitude changes.
- Do not use this watch for measuring altitude in applications that demand professional or industrial level precision.
- Remember that the air inside of a commercial aircraft is pressurized. Because of this, the readings produced by this watch will not match the altitude readings announced or indicated by the flight crew.

**Precautions Concerning Simultaneous Altitude and Temperature Readings**

For the more accurate altitude readings, leaving the watch on your wrist is recommended in order to maintain the watch at a constant temperature.

- When taking temperature readings, keep the watch at as stable a temperature as possible. Changes in temperature can affect temperature readings. See product specifications (page E-107) for sensor accuracy information.

**Taking Barometric Pressure Readings**

This watch uses a pressure sensor to measure air pressure (barometric pressure).

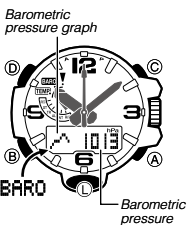

**To take barometric pressure readings**

- Use **(B)** to select the Barometer Mode (**BARO**), as shown on page E-30.
- **BARO** will appear on the display, indicating that barometric pressure reading is in progress. The results will appear on the display after about one second.
  - After a barometric pressure reading operation is started, the watch will take readings every five seconds for the first three minutes, and then every two minutes after that.
  - To restart a reading operation from the beginning, press **(A)**.
  - The watch will return to the Timekeeping Mode automatically if you do not perform any operation for about one hour after entering the Barometer Mode.

**Note**

- When you press **(B)** above, the second hand may indicate seconds (of the current time) or the barometric pressure differential (page E-71). The initial second hand function will be the same as what was selected the last time you took a barometric pressure reading. To toggle between the two second hand functions (indicating seconds or indicating the barometric pressure differential) press **(D)**.

Barometric pressure change indicator

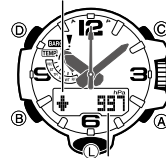

Barometric pressure

**Barometric Pressure**

- Barometric pressure is displayed in units of 1 hPa (or 0.05 inHg).
- The displayed barometric pressure value changes to --- if a measured barometric pressure falls outside the range of 260 hPa to 1,100 hPa (7.65 inHg to 32.45 inHg). The barometric pressure value will reappear as soon as the measured barometric pressure is within the allowable range.

**Display Units**

You can select either hectopascals (hPa) or inchesHg (inHg) as the display unit for the measured barometric pressure. See "To specify altitude, barometric pressure, and temperature units" (page E-51).

**Barometric Pressure Graph**

Barometric pressure graph



Barometric pressure indicates changes in the atmosphere. By monitoring these changes you can predict the weather with reasonable accuracy. This watch takes barometric pressure reading automatically every two hours. Readings are used to produce barometric pressure graph and barometric pressure differential pointer readings.

**Reading the Barometric Pressure Graph**

The barometric pressure graph shows a chronological history of pressure readings.

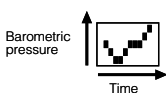

- The horizontal axis of the graph represents time, with each dot standing for two hours. The rightmost dot represents the most recent reading.
- The vertical axis of the graph represents barometric pressure, with each dot standing for the relative difference between its reading and that of the dots next to it. Each dot represents 1 hPa.

The following shows how to interpret the data that appears on the barometric pressure graph.



Rising barometric pressure indicates that upcoming weather will improve.



Falling barometric pressure indicates that upcoming weather will deteriorate.

**Note**

- If there are sudden changes in weather or temperature, the graph line of past reading may run off the top or bottom of the display.
- The following conditions cause the barometric pressure reading to be skipped, with the corresponding point on the barometric pressure graph being left blank.
  - Barometric reading that is out of range (260 hPa to 1,100 hPa or 7.65 inHg to 32.45 inHg)
  - Sensor malfunction
- The barometric pressure graph is not displayed while the barometric pressure change indicator is displayed.

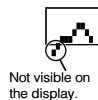

Not visible on the display.

**Barometric Pressure Differential Pointer**



This pointer indicates the relative difference between the most recent barometric pressure reading indicated on the barometric pressure graph (page E-69), and the current barometric pressure value displayed in the Barometer Mode (page E-68).

**To show and hide barometric pressure differential**

1. Use **(B)** to enter the Barometer Mode (**BARO**), as shown on page E-30.
2. Press **(D)**.

**Note**

- Press **(D)** to toggle the second hand between its two functions (indicating seconds or indicating the barometric pressure differential).

## Reading Barometric Pressure Differential Pointer

Pressure differential is indicated in the range of  $\pm 10$  hPa (0.3 inHg), in 1-hPa (0.03 inHg) units.

- The nearby screen shot, for example, shows what the second hand would indicate when the calculated pressure differential is approximately  $-5$  hPa (approximately  $-0.15$  inHg).
- The second hand will point to **OVER** ( $\blacktriangleright$ ) or **UNDER** ( $\blacktriangleleft$ ) if the barometric pressure differential is outside the allowable range of the scale.
- The second hand will move to 9 o'clock if a sensor reading could not be taken for some reason or if the reading is outside the allowable range.
- Barometric pressure is calculated and displayed using hPa as the standard. The barometric pressure differential also can be read in inHg units as shown in the illustration ( $1 \text{ hPa} \approx 0.03 \text{ inHg}$ ).

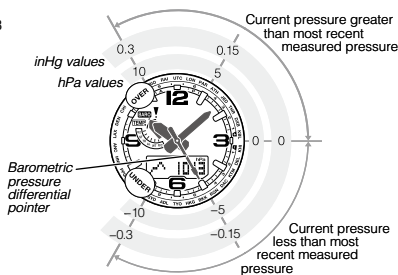

## Barometric Pressure Change Indications

Your watch analyzes past barometric pressure readings and uses a barometric pressure change indicator to inform you about changes in pressure. If the watch detects a significant change in barometric pressure, it will beep and display a flashing arrow that indicates the direction of the pressure change. This means you could start taking barometric pressure readings after reaching a lodge or camp area, and then check the watch the next morning for changes in pressure, and plan your day's activities accordingly. Note that you can enable or disable display of the barometric pressure change indicator as desired. The barometric pressure change indicator is displayed in the Barometer Mode and while the barometric pressure graph is displayed in the Timekeeping Mode (page E-33).

### Reading the Barometric Pressure Change Indicator

Indicator	Meaning
	Sudden fall in pressure.
	Sudden rise in pressure.
	Sustained rise in pressure, changing to a fall.
	Sustained fall in pressure, changing to a rise.

- The barometric pressure change indicator is not displayed if there has been no noteworthy change in barometric pressure.

E-72

E-73

## Important!

- To ensure proper results, take barometric readings under conditions where the altitude remains constant.

### Example

- In a lodge or campground
- On the ocean

- A change in altitude causes a change in barometric pressure. Because of this, correct readings are impossible. Do not take readings while ascending or descending a mountain, etc.

### Enabling or Disabling Display of the Barometric Pressure Change Indicator

You can enable or disable display of the barometric pressure change indicator as desired. When display of the indicator is enabled, the watch will take a barometric pressure reading every two minutes, regardless of the mode it is in.

- When **BARO** is shown on the display, it means that barometric pressure change indicator display is enabled.
- When **BARO** is not on the display, it means that barometric pressure change indicator display is disabled.

### To enable or disable the barometric pressure change indicator

In the Barometer Mode, hold down (D) for at least two seconds. Wait until **INFO** appears on the left side of the display and the current setting (**ON** or **OFF**) flashes on the right. Use this screen to enable or disable the barometric pressure change indicator.

- If barometric pressure change indicator display is currently enabled, **BARO** will also appear in the upper display. **BARO** will not appear if display is currently disabled.
- Note that barometric pressure change indicator display will turn off automatically 24 hours after you turn it on or battery power goes low.

E-74

- Note that time calibration signal reception and power saving (page E-18) are disabled while barometric pressure change indicator display is enabled.

- Note that barometric pressure change indicator display cannot be enabled while the watch's battery is low.

### Pressure Sensor Calibration

The pressure sensor built into the watch are calibrated at the factory and normally require no further adjustment. If you notice serious errors in the pressure readings produced by the watch, you can calibrate the sensor to correct the errors.

### Important!

- Incorrectly calibrating the barometric pressure sensor can result in incorrect readings. Before performing the calibration procedure, compare the readings produced by the watch with those of another reliable and accurate barometer.

### To calibrate the pressure sensor

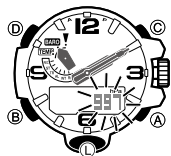

- Take a reading with another measurement device to determine the exact current barometric pressure.
- Use (B) to enter the Barometer Mode (**BARO**), as shown on page E-30.
- Pull out the crown. This will cause the current barometric pressure reading value to flash on the digital display.
- Rotate the crown to adjust the barometric pressure value.
  - The calibration unit is 1 hPa (0.05 inHg).
  - To return the currently flashing value to its initial factory default setting, press (A) and (C) at the same time. **OFF** will appear at the flashing location for about one second, followed by the initial default value.
- After you complete calibration, push the crown back in.

### Barometer Precautions

- The pressure sensor built into this watch measures changes in air pressure, which you can then apply to your own weather predictions. It is not intended for use as a precision instrument in official weather prediction or reporting applications.
- Sudden temperature changes can affect pressure sensor readings. Because of this, there may be some error in the readings produced by the watch.

E-76

## Taking Temperature Readings

This watch uses a temperature sensor to measure temperature.

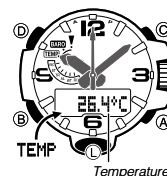

### To take temperature readings

Use (B) to select the Thermometer Mode (**TEMP**), as shown on page E-30.

- TEMP** will appear on the display, indicating that temperature reading is in progress. The results will appear on the display after about one second.
- After a temperature reading operation is started, the watch will take readings every five seconds for the first three minutes, and then every two minutes after that.
- To restart a reading operation from the beginning, press (A).
- The watch will return to the Timekeeping Mode automatically if you do not perform any operation for about 1 hour after entering the Thermometer Mode.

### Temperature

- Temperature is displayed in units of  $0.1^\circ\text{C}$  (or  $0.2^\circ\text{F}$ ).
- The displayed temperature value changes to  $--. --^\circ\text{C}$  (or  $^\circ\text{F}$ ) if a measured temperature falls outside the range of  $-10.0^\circ\text{C}$  to  $60.0^\circ\text{C}$  ( $14.0^\circ\text{F}$  to  $140.0^\circ\text{F}$ ). The temperature value will reappear as soon as the measured temperature is within the allowable range.

### Display Units

You can select Celsius ( $^\circ\text{C}$ ) or Fahrenheit ( $^\circ\text{F}$ ) as the display unit for the measured temperature value. See "To specify altitude, barometric pressure, and temperature units" (page E-51).

## Temperature Sensor Calibration

The temperature sensor built into the watch are calibrated at the factory and normally require no further adjustment. If you notice serious errors in the temperature readings produced by the watch, you can calibrate the sensor to correct the errors.

### Important!

- Incorrectly calibrating the temperature sensor can result in incorrect readings. Carefully read the following before doing anything.
  - Compare the readings produced by the watch with those of another reliable and accurate thermometer.
  - If adjustment is required, remove the watch from your wrist and wait for 20 or 30 minutes to give the temperature of the watch time to stabilize.

### To calibrate the temperature sensor



- Take a reading with another measurement device to determine the exact current temperature.
- Use (B) to enter the Thermometer Mode (**TEMP**), as shown on page E-30.
- Pull out the crown. This will cause the current temperature reading value to flash on the digital display.
- Rotate the crown to adjust the temperature value.
  - The calibration unit is  $0.1^\circ\text{C}$  ( $0.2^\circ\text{F}$ ).
  - To return the currently flashing value to its initial factory default setting, press (A) and (C) at the same time. **OFF** will appear at the flashing location for about one second, followed by the initial default value.
- After you complete calibration, push the crown back in.

E-78

## Thermometer Precautions

- Temperature readings are affected by your body temperature, direct sunlight, and moisture. To achieve a more accurate temperature reading, remove the watch from your wrist, place it in a well ventilated location out of direct sunlight, and wipe all moisture from the case. It takes approximately 20 to 30 minutes for the case of the watch to reach the surrounding temperature.

E-77

E-79

## Viewing Altitude Records

You can use the Data Recall Mode to view manually saved record data and auto save values.

### To view altitude records

- Use **(B)** to select the Data Recall Mode (**RECALL**) as shown on page E-30.
  - About one second after **RECALL** appears on the display, the display will change to show the first record of the memory area you were viewing when you last exited the Data Recall Mode.
- Use **(A)** and **(C)** to scroll through the screens for an area and display the one you want.

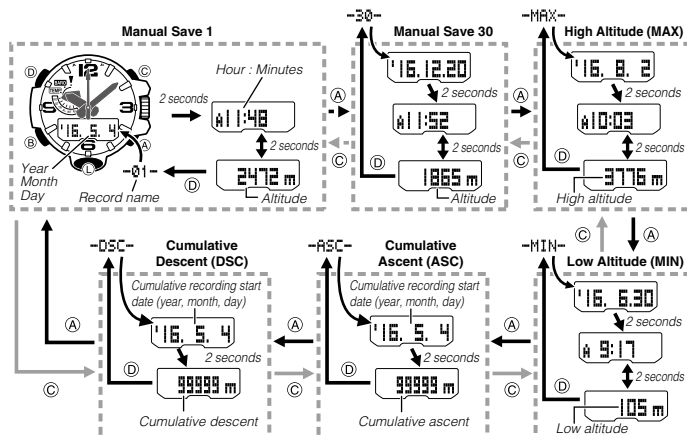

E-80

E-81

- Manually saved records (**REC01 to REC30**) and auto save **MAX** and **MIN** values all include the date (year, month and day) and time (hour and minute) that the data was recorded.
- Records of the **ASC** and **DSC** include altitude values along with the date (year, month, day) that the data was recorded.
- For details about auto save values, see "Auto Save Values" (page E-62).
- will be displayed if **MAX**/**MIN** data has been deleted or if there is no corresponding **MAX**/**MIN** data due to error, etc. In such cases, total ascent (**ASC**) and total descent (**DSC**) values will show zero.

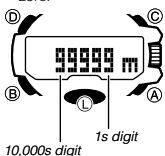

- When the total ascent (**ASC**) or total descent (**DSC**) exceeds 99,999 meters (or 327,995 feet), the applicable value will restart from zero.

### To delete all recorded data

- Use **(B)** to enter the Data Recall Mode.
- Hold down **(D)** for at least three seconds. Keep **(D)** depressed when **CLEAR ALL** starts to flash on the display, and release it when **CLEAR ALL** stops flashing (and remains displayed).
  - -:- and -:- will alternate on the display.

### To delete a specific record

- Use **(B)** to enter the Data Recall Mode.
- (A)** and **(C)** to display the record you want to delete.

#### Important!

- Note that holding down **(D)** for more than five seconds in step 3 will delete all data.
  - A delete operation cannot be undone! Make sure you do not need data before you delete it.
- Hold down **(D)**. Keep **(D)** depressed when **CLEAR** starts to flash on the display, and release it as soon as **CLEAR** stops flashing (and remains displayed).
    - Deleting a record in the manually saved record memory area causes all of the records following it to be shifted upwards and renumbered accordingly.

E-82

E-83

## Using the Stopwatch

The stopwatch measures elapsed time, split times, and two finishes.

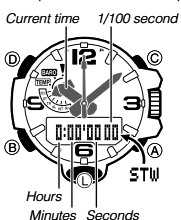

### To enter the Stopwatch Mode

Use **(B)** to select the Stopwatch Mode (**STW**) as shown on page E-30.

### To perform an elapsed time operation

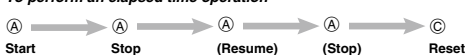

### To pause at a split time



### To measure two finishes

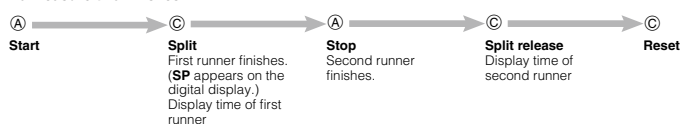

#### Note

- The Stopwatch Mode can indicate elapsed time up to 23 hours, 59 minutes, 59.99 seconds.
- An ongoing elapsed time measurement operation will continue internally even if you change to another mode. However, if you exit the Stopwatch Mode while a split time is displayed, the split time will not be displayed when you return to the Stopwatch Mode.

E-84

E-85

## Using the Countdown Timer

The countdown timer can be configured to start at a preset time, and sound an alarm when the end of the countdown is reached.

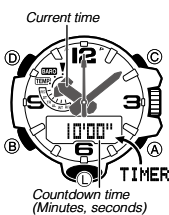

### To enter the Countdown Timer Mode

Use **(B)** to select the Countdown Timer Mode (**TIMER**) as shown on page E-30.

- About one second after **TIMER** appears on the display, the display will change to show the countdown time hours.

### To specify the countdown start time

- Enter the Countdown Timer Mode.
- Pull out the crown.
  - This will cause the current start time minutes digits to flash on the digital display.
- Rotate the crown to adjust the minutes setting.
  - To set a starting countdown time of 60 minutes, set 00'00.
- After the setting is the way you want, push the crown back in.

### To perform a countdown timer operation



- An alarm sounds for ten seconds when the end of the countdown is reached. This alarm will sound in all modes. The countdown time is reset to its starting value automatically when the alarm sounds.

### To stop the alarm

Press any button.

E-86

E-87

## Using the Alarm

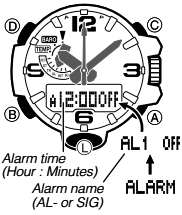

You can set five independent daily alarms. When an alarm is turned on, an alarm will sound for about 10 seconds each day when the time in the Timekeeping Mode reaches the preset alarm time. This is true even if the watch is not in the Timekeeping Mode. You can also turn on an Hourly Time Signal, which will cause the watch to beep twice every hour on the hour.

### To enter the Alarm Mode

- Use **(B)** to select the Alarm Mode (**ALARM**) as shown on page E-30.
- About one second after **ALARM** appears on the display, the display will change to show an alarm name (**AL1** through **AL5**) or the **SIG** indicator. The alarm name indicates an alarm screen. **SIG** is shown when the Hourly Time Signal screen is on the display.
- When you enter the Alarm Mode, the data you were viewing when you last exited the mode appears first.

E-88

## To set an alarm time



- In the Alarm Mode, use **(A)** and **(C)** to scroll through the alarm screens until the one whose time you want to set is displayed.

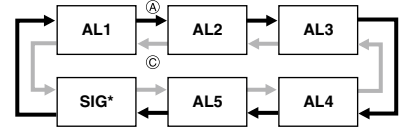

\* There is no time setting for the hourly time signal.

- Pull out the crown.
  - This will cause the hour and minute digits of the alarm time to flash.
- Rotate the crown to adjust the minute setting.
  - Hour setting will change in accordance with minute setting changes.
- Press **(B)**.
- Rotate the crown to adjust the hour setting.
  - If you are using 12-hour timekeeping, the **P** (p.m.) and **A** (a.m.) indicators will also appear on the display.
- After the settings are the way you want, push the crown back in.
  - Setting an alarm time causes that alarm to turn on automatically.

E-89

## To turn an alarm and the Hourly Time Signal on and off

- In the Alarm Mode, use **(A)** and **(C)** to select an alarm or the Hourly Time Signal.
- When the alarm or the Hourly Time Signal you want is selected, press **(B)** to turn it on and off.
  - The alarm on indicator (when any alarm is on), and the Hourly Time Signal on indicator (when the Hourly Time Signal is on) are shown on the display in all modes.

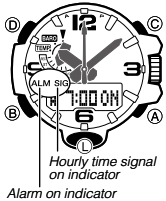

**To stop the alarm**  
Press any button.

**To test the alarm**  
In the Alarm Mode, hold down **(A)** to sound the alarm tone.

E-90

## Checking the Current Time in a Different Time Zone

You can use the World Time Mode to display the current time in any one of 29 time zones (29 cities) around the world, and in the UTC (Universal Time Coordinated) time zone. The city that is currently selected in the World Time Mode is called the "World Time City".

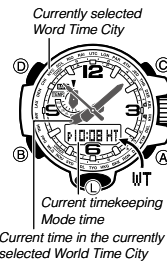

### To enter the World Time Mode

- Use **(B)** to select the World Time Mode (**WT**) as shown on page E-30. This causes **WT** to appear on the digital display. After one second, the hour and minute hands move to indicate the time in the current World Time City. The second hand points to the city code of the currently selected World Time City.
- The digital display shows the current time in the Home City.
- To check whether the indicated World Time City time is a.m. or p.m., press **(A)**. This will cause the second hand to move to **A** (a.m.) or **P** (p.m.) The second hand will return to regular timekeeping after about three seconds.
- Pressing **(D)** will cause the second hand to move to the currently selected World Time City city code. The second hand will return to regular timekeeping after about three seconds.

Current time in the currently selected World Time City

E-91

## To configure World Time City and summer time settings



- In the World Time Mode, pull out the crown.
  - This will cause **CITY** to flash on the digital display.
- Rotate the crown to move the second hand to the City Code you want to select.
  - The currently selected World Time City will be indicated by the second hand.
- Press **(B)**.
  - This will cause the current DST setting (**DST ON** or **DST OFF**) to flash on the display.
- Rotate the crown to select either on (**DST ON**) or off (**DST OFF**) for the DST setting.
- After the settings are the way you want, push the crown back in.
  - Note that you cannot switch between standard time/daylight saving time (DST) while **UTC** is selected as the World Time City.
  - Note that the standard time/daylight saving time (DST) setting affects only the currently selected time zone. Other time zones are not affected.

E-92

## To swap your Home City and World Time City



- In the World Time Mode, hold down **(D)** for at least three seconds.
- After **CITY** flashes on the digital display, the watch will swap the Home City and World Time City settings. With the above example, the second hand will move to **TYO** (Tokyo). The hour and minute hands will move to the current time in Tokyo (**TYO**).
- The second hand will return to regular timekeeping after about three seconds.
- With the above example, the digital display will now show the current time in New York (**NYC**).

## To access the UTC (Universal Time Coordinated) time zone

- In the World Time Mode, hold down **(A)** for at least three seconds.
- This will cause **UTC** to flash on the digital display, and then the hour and minute hands will move to the current time in the UTC time zone. The second hand will move to the UTC city code at this time. The second hand will return to regular timekeeping after about three seconds.

E-94

## Swapping the Home City and World Time City

You can use the procedure below to swap your Home City with your World Time City. This function comes in handy for those who often travel between two different time zones. The following example shows what happens when the Home City and World Time City are swapped while the Home City originally is **TOKYO (TYO)** and the World Time City is **NEW YORK (NYC)**.

	Home City	World Time City
Before swapping	Tokyo 10:08 p.m. (Standard time)	New York 9:08 a.m. (Daylight saving time)
After swapping	New York 9:08 a.m. (Daylight saving time)	Tokyo 10:08 p.m. (Standard time)

\* The procedure below assumes that World Time Mode settings start with the analog hands indicating New York (**NYC**) time and the digital display indicating Tokyo (**TYO**) time.

E-93

## Illumination

The display of the watch is illuminated for easy reading in the dark. The watch's auto light switch turns on illumination automatically when you angle the watch towards your face.

\* The auto light switch must be turned on (page E-97) for it to operate.

### To turn on illumination manually

- Press **(L)** in any mode to illuminate the display.
- Illumination will turn off automatically if an alarm starts to sound or if you perform a crown operation.
- Illumination will not turn on if a calibration signal receive operation or hand movement operation is in progress. Also, illumination may not turn on while a sensor is taking a reading.

### To change the illumination duration

- In the Timekeeping Mode, pull out the crown.
- Press **(B)** four times. This will cause **LIGHT** to appear on the digital display, along with a flashing value (**1** or **3**) indicating the current illumination duration setting.
- Rotate the crown to select either **1** (1.5 seconds) or **3** (three seconds) for the illumination duration.
- After the setting is the way you want, push the crown back in.

E-95



## About the Auto Light Switch

Turning on the auto light switch causes illumination to turn on, whenever you position your wrist as described below in any mode. **Moving the watch to a position that is parallel to the ground and then tilting it towards you more than 40 degrees causes illumination to turn on.**



### Warning!

- Always make sure you are in a safe place whenever you are reading the display of the watch using the auto light switch. Be especially careful when running or engaged in any other activity that can result in accident or injury. Also take care that sudden illumination by the auto light switch does not startle or distract others around you.
- When you are wearing the watch, make sure that its auto light switch is turned off before riding on a bicycle or operating a motorcycle or any other motor vehicle. Sudden and unintended operation of the auto light switch can create a distraction, which can result in a traffic accident and serious personal injury.

E-96

### Note

- This watch features a "Full Auto Light", so the auto light switch operates only when available light is below a certain level. It does not illuminate the display under bright light.
- The auto light switch is always disabled, regardless of its on/off setting, when any one of the following conditions exists.
  - While any tone (alarm, timer, etc.) is sounding
  - While the watch is in the Digital Compass Mode
  - While a receive operation is in progress
  - While a hand movement operation is in progress
- If you have Auto Light enabled, display illumination may be delayed if you angle the watch towards your face while a barometric pressure, altitude, or temperature reading operation is being performed.

### To enable or disable the auto light switch

1. In the Timekeeping Mode, pull out the crown.
2. Press **(B)** three times. This will cause **AUTO** to appear on the left of the digital display, along with the flashing current auto light switch setting (**ON** or **OFF**) on the right.
3. Rotate the crown to select either enabled (**ON**) or disabled (**OFF**) for the auto light switch setting.
4. Push the crown back in.
  - The auto light switch turns off automatically whenever battery power drops to Level 4 (page E-14).

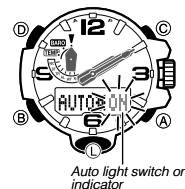

E-97

## Illumination Precautions

- The LED that provides illumination loses power after very long use.
- Illumination may be hard to see when viewed under direct sunlight.
- Illumination turns off automatically whenever an alarm sounds.
- Frequent use of illumination runs down the battery.

### Auto light switch precautions

- Wearing the watch on the inside of your wrist, movement of your arm, or vibration of your arm can cause frequent activation of the auto light switch and illumination of the display. To avoid running down the battery, turn off the auto light switch whenever engaging in activities that might cause frequent illumination of the display.
- Note that wearing the watch under your sleeve while the auto light switch is turned on can cause frequent illumination of the display and can run down the battery.



- Illumination may not turn on if the face of the watch is more than 15 degrees above or below parallel. Make sure that the back of your hand is parallel to the ground.
- Illumination turns off after the preset illumination duration (page E-95), even if you keep the watch pointed towards your face.
- Static electricity or magnetic force can interfere with proper operation of the auto light switch. If illumination does not turn on, try moving the watch back to the starting position (parallel with the ground) and then tilt it back towards your face again. If this does not work, drop your arm all the way down so it hangs at your side, and then bring it back up again.
- You may notice a very faint clicking sound coming from the watch when it is shaken back and forth. This sound is caused by mechanical operation of the auto light switch, and does not indicate a problem with the watch.

E-98

## Other Settings

The button operation tone sounds any time you press one of the watch's buttons. You can turn the button operation tone on or off as desired.

\* Even if you turn off the button operation tone, the alarm, Hourly Time Signal, barometric pressure change indicator, and Countdown Timer Mode alarm all operate normally.

### To turn the button operation tone on or off

1. In the Timekeeping Mode, pull out the crown.
2. Press **(@)** twice. This will cause the current button operation tone setting (**KEY** or **MUTE**) to flash on the digital display.
3. Rotate the crown to select either on (**KEY**) or off (**MUTE**) for the button operation tone setting.
4. Push the crown back in.

### To turn Power Saving on or off

1. In the Timekeeping Mode, pull out the crown.
2. Press **(@)** six times. This will cause **P.SAVE** to appear on the digital display, along with the flashing current Power Saving setting (**ON** or **OFF**).
3. Rotate the crown to select either on (**ON**) or off (**OFF**) for the Power Saving setting.
4. Push the crown back in.

E-99

## Troubleshooting

### Time Setting

See "Radio Controlled Atomic Timekeeping" (page E-19) for information about adjusting the time setting according to a time calibration signal.

#### ■ The current time setting is off by hours.

Your Home City setting may be wrong (page E-34). Check your Home City setting and correct it, if necessary.

#### ■ The current time setting is off by one hour.

If you are using the watch in an area where time calibration signal reception is possible, see "To configure Home City and summer time settings" (page E-34).

If you are using in the watch in an area where time calibration signal reception is not possible, you may need to change your Home City's standard time/daylight saving time (DST) setting manually. Use the procedure under "To change the current time and date settings manually" (page E-36) to change the standard time/daylight saving time (DST) setting.

### Altitude Readings

#### ■ Altitude readings produce different results at the same location.

■ Readings produced by the watch are different from the elevation and/or sea level altitude indications in my area. (Negative sea level altitude values are produced in a location where the indicated elevation is a positive value.)

E-100

#### ■ I can't get correct altitude readings.

Relative altitude is calculated based on changes in barometric pressure measurement by its pressure sensor. This means that barometric pressure changes can cause readings taken at different times at the same location to be different. Also note that the value displayed by the watch may be different from the actual elevation and/or sea level elevation indicated for the area where you are located. When using the watch's altimeter while mountain climbing, you need to be sure to perform regular calibration in accordance with the local altitude (elevation) indications. For more information, see "To specify a reference altitude value" (page E-56).

#### ■ Following a relative altitude reading, the watch's second hand points to 9 o'clock.

- The reading value is outside of the allowable measurement range. See page E-54.
- This could indicate sensor error. If **ERR** (error) is on the digital display, refer to "Direction, Altitude, Barometric Pressure, and Temperature Readings" (page E-103) for more information.

### Taking Direction Readings



#### ■ Abnormal magnetism detection is indicated.

- Move away from any potential source of strong magnetism and try taking a reading again.
- If abnormal magnetism is detected again when you retry, it could mean that the watch itself has become magnetized. If this happens, continue to keep away from the source of strong magnetism, perform bidirectional calibration, and then try taking a reading again. For more information, refer to "To perform bidirectional calibration" (page E-47) and "Location" (page E-50).

E-101

#### ■ ERR appears on the digital display during sensor reading operations.

There is something wrong with the sensor. This could be due to nearby strong magnetic force. Move location where magnetism is not present and try again. If, after multiple retries, **ERR** keeps appearing, contact your original retailer or CASIO service center. See "Location" (page E-50).

#### ■ ERR appears following bidirectional calibration.

If the screen displays hyphens (---) followed by the **ERR** (error) indicator, it could mean there is something wrong with the sensor.

- Wait for about one second for the **ERR** indicator to disappear from the display, and then calibrate the sensor again.
- If **ERR** continues to appear even after multiple attempts to calibrate, contact your original retailer or CASIO service center.

#### ■ The direction information indicated by the watch is different from that indicated by a backup compass.

• Move away from and potential source of strong magnetism, perform bidirectional calibration, and then try taking a reading again. For more information, refer to "To perform bidirectional calibration" (page E-47) and "Location" (page E-50).

#### ■ Direction readings produce different results at the same location.

• Move away from any potential source of strong magnetism and try taking a reading again. See "Location" (page E-50).

#### ■ I am having problems taking direction readings indoors.

• Move away from any potential source of strong magnetism and try taking a reading again. See "Location" (page E-50).

E-102

Whenever you have a sensor malfunction, take the watch to your original retailer or nearest authorized CASIO distributor as soon as possible.

### Barometric Pressure Readings

#### ■ Following a relative barometric pressure reading, the watch's second hand points to 9 o'clock.

- The reading value is outside of the allowable measurement range. See page E-72.
- There may be a problem with the sensor. If **ERR** (error) is on the digital display, refer to "Direction, Altitude, Barometric Pressure, and Temperature Readings" for more information.

### Direction, Altitude, Barometric Pressure, and Temperature Readings

#### ■ ERR appears on the digital display during sensor reading operations.

- This indicates that there is a problem with the sensor, making sensor readings impossible.
- If the error is indicated while a reading operation in progress, restart the operation. If **ERR** appears again, it could mean there is something wrong with the sensor.
- If **ERR** appears frequently, it could mean that the sensor is faulty. Contact your original retailer or CASIO service center.

#### ■ I can't change the temperature, barometric pressure, and altitude display units.

When **TYO** (Tokyo) is selected as the Home City, the altitude unit is set automatically to meters (m), the barometric pressure unit to hectopascals (hPa), and the temperature unit to Celsius (°C). These settings cannot be changed.

E-103



## World Time Mode

### ■ The time for my World Time City is off in the World Time Mode.

This could be due to incorrect switching between standard time and daylight saving time. See "To configure World Time City and summer time settings" (page E-92) for more information.

## Charging

### ■ The watch does not resume operation after I expose it to light.

This can happen after the power level drops to Level 5 (page E-14). Keep the watch exposed to light until it recharges sufficiently.

### ■ RECOVER is flashing on the digital display.

The watch is in the charge recovery mode. Wait until the recovery process is complete (about 15 minutes). The watch will recover more quickly if you place it in a brightly lit location.

## Note

- Performing repeated illumination and/or sensor reading operations over a short time period can cause a sudden drop in watch's charge. This will cause the watch to enter the charge recovery mode. The watch is in the charge recovery mode when **RECOVER** is flashing on the digital display. The charge recovery mode is the same as a low battery charge state, access to some functions is limited while the watch charge is recovering. Normal operation will resume after recovery is complete. For more information, refer to "Power Recovery Mode" (page E-16).
- A flashing **CHARGE** indicator means that the charge level of the watch has suddenly dropped. Immediately expose the watch to light to charge it.

E-104

## Time Calibration Signal

The information in this section applies only when **LON, PAR, ATH, HKG, HNL, ANC, LAX, DEN, CHI, NYC, or TYO** is selected as the Home City. You need to adjust the current time manually when any other city is selected as the Home City.

### ■ The display shows the ERR indicator when I check the result of the latest receive operation.

Possible Cause	Remedy	Page
<ul style="list-style-type: none"> <li>You are wearing or moving the watch, or performing a button operation during the signal receive operation.</li> <li>The watch is in an area with poor reception conditions.</li> </ul>	Keep the watch in an area where reception conditions are good while the signal receive operation is performed.	E-21
You are in an area where signal reception is not possible for some reason.	See "Approximate Reception Ranges".	E-20
The calibration signal is not being transmitted for some reason.	<ul style="list-style-type: none"> <li>Check the website of the organization that maintains the time calibration signal in your area for information about its down times.</li> <li>Try again later.</li> </ul>	-

### ■ The current time setting changes after I set it manually.

You may have the watch configured for auto receive of the time calibration signal (page E-22), which will cause the time to be adjusted automatically according to your currently selected Home City. If this results in the wrong time setting, check your Home City setting and correct it, if necessary (page E-34).

E-105

### ■ The current time setting is off by one hour.

Possible Cause	Remedy	Page
Signal reception on a day for switching between standard time/daylight saving time (DST) may have failed for some reason.	Perform the operation under "To get ready for a receive operation". The time setting will be adjusted automatically as soon as signal reception is successful.	E-21
	If you are unable to receive the time calibration signal, change the standard time/daylight saving time (DST) setting manually.	E-36

### ■ Auto receive is not performed or you cannot perform manual receive.

Possible Cause	Remedy	Page
The watch is not in the Timekeeping Mode.	Auto receive is performed only while the watch is in the Timekeeping Mode. Enter the Timekeeping Mode.	E-30
Your Home City setting is wrong.	Check your Home City setting and correct it, if necessary.	E-34
There is not enough power for signal reception.	Expose the watch to light to charge it.	E-12

### ■ Signal reception is being performed successfully, but the time and/or day is wrong.

Possible Cause	Remedy	Page
Your Home City setting is wrong.	Check your Home City setting and correct it, if necessary.	E-34
The DST setting may be incorrect.	Change the DST setting to Auto DST.	E-34

E-106

## Specifications

**Accuracy at normal temperature:** ±15 seconds a month (with no signal calibration)

**Digital Timekeeping:** Hour, minutes, seconds, a.m. (A)/ p.m. (P), month, day, day of the week, barometric pressure change indication  
 Time format: 12-hour and 24-hour  
 Calendar system: Full Auto-calendar pre-programmed from the year 2000 to 2099  
 Other: Three display formats (day of the week, month, day; barometric pressure change, month day; hour, minute, second); Home City code (can be assigned one of 29 city codes); standard time / daylight saving time (summer time)

**Analog Timekeeping:** Hour, minutes (hand moves every 10 seconds), seconds

**Time Calibration Signal Reception:** Auto receive 6 times a day (5 times a day for the Chinese calibration signal); Remaining auto receives cancelled as soon as one is successful; Manual receive; Receive Mode  
 Receivable Time Calibration Signals: Mainflingen, Germany (Call Sign: DCF77, Frequency: 77.5 kHz); Anthorn, England (Call Sign: MSF, Frequency: 60.0 kHz); Fort Collins, Colorado, the United States (Call Sign: WWVB, Frequency: 60.0 kHz); Fukushima, Japan (Call Sign: JJY, Frequency: 40.0 kHz); Fukuoka/Saga, Japan (Call Sign: JJY, Frequency: 60.0 kHz); Shangqiu City, Henan Province, China (Call Sign: BPC, Frequency: 68.5 kHz)

**Digital Compass:** 60 seconds continuous reading; 16 directions; Angle value 0° to 359°; Measurement unit: 1° (digital display)/6° (hand); North indicated by second hand; Compass calibration (bidirectional, magnetic declination angle)

E-107

## Altimeter:

Measurement range: -700 to 10,000 m (or -2,300 to 32,800 ft.) without reference altitude  
 Display range: -3,000 to 10,000 m (or -9,840 to 32,800 ft.)  
 Negative values can be caused by readings produced based on a reference altitude or due to atmospheric conditions.

Measurement Unit: 1 m (or 5 ft.)  
 Current Altitude Data: Every second for the first 3 minutes, followed by every 5 seconds for approximately 1 hour (0'05); every second for the first 3 minutes, followed by every 2 minutes for approximately 12 hours (2'00)

Altitude Memory Data:  
 Manually saved records: 30 (altitude, date, time)  
 Auto saved values: One set of high altitude and its reading date and time, low altitude and its reading date and time, total ascent and its save start date and time, total descent and its save start date and time  
 Other: Reference altitude setting; Altitude differential (-100 to +100m/-1,000 to +1,000m); Altitude auto measurement interval (0'05 or 2'00)

## Barometer:

Measurement and display range:  
 260 to 1,100 hPa (or 7.65 to 32.45 inHg)  
 Display unit: 1 hPa (or 0.05 inHg)  
 Other: Calibration; Barometric pressure graph; Barometric pressure differential pointer; Barometric pressure change indicator

## Thermometer:

Measurement and display range: -10.0 to 60.0°C (or 14.0 to 140.0°F)  
 Display unit: 0.1°C (or 0.2°F)  
 Other: Calibration

E-108

## Bearing Sensor Precision:

Direction: Within ±10°  
 Values are guaranteed for a temperature range of 10°C to 40°C (50°F to 104°F).  
 North indicated by second hand: Within ±2 segments

## Pressure Sensor Precision:

Measurement accuracy: Within ±3hPa (0.1 inHg) (Altimeter accuracy: Within ± 75m (246 ft.))  
 Values are guaranteed for a temperature range of -10°C to 40°C (14°F to 104°F).  
 Precision is lessened by strong impact to either the watch or the sensor, and by temperature extremes.

## Temperature Sensor Precision:

±2°C (±3.6°F) in range of -10°C to 60°C (14.0°F to 140.0°F)

## Stopwatch:

Measuring unit: 1/100 second  
 Measuring capacity: 23:59' 59.99"  
 Measuring modes: Elapsed time, split time, two finishes

## Countdown Timer:

Measuring unit: 1 second  
 Countdown range: 60 minutes  
 Setting unit: 1 minute

## Alarms: 5 Daily alarms; Hourly time signal

**World Time:** 29 cities (29 time zones), UTC (Universal Time Coordinated); Home City/World Time City switching; one-touch UTC zone access  
 Other: Daylight Saving Time/Standard Time

**Illumination:** LED light; Selectable illumination duration (approximately 1.5 seconds or 3 seconds); Auto Light Switch (Full Auto Light operates only in the dark)

E-109

**Other:** Battery power indicator; Power Saving; Button operation tone on/off; alarm test; auto hand position adjustment; hand shift feature (to view digital info)

## Power Supply: Solar panel and one rechargeable battery

Approximate battery operating time: 6 months (from full charge to Level 4) under the following conditions:

- Light: 1.5 seconds/day
- Beeper: 10 seconds/day
- Direction readings: 20 times/month
- Climbs: Once (approximately 1 hour of altitude readings)/month
- Barometric pressure change indicator readings: Approximately 24 hours/month
- Barometric pressure graph: Readings every 2 hours
- Time calibration receive: 4 minutes/day
- Display: 18 hours/day

Frequent use of illumination runs down the battery. Particular care is required when using the auto light switch (page E-98).

E-110



## City Code Table

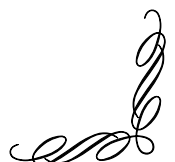

L-1

## City Code Table

City Code	City	UTC Offset/ GMT Differential
PPG	Pago Pago	-11
HNL	Honolulu	-10
ANC	Anchorage	-9
LAX	Los Angeles	-8
DEN	Denver	-7
CHI	Chicago	-6
NYC	New York	-5
SCL	Santiago	-4
RIO	Rio De Janeiro	-3
RAI	Praia	-1
UTC		0
LON	London	
PAR	Paris	+1
ATH	Athens	+2
JED	Jeddah	+3
THR	Tehran	+3.5
DXB	Dubai	+4

City Code	City	UTC Offset/ GMT Differential
KBL	Kabul	+4.5
KHI	Karachi	+5
DEL	Delhi	+5.5
KTM	Kathmandu	+5.75
DAC	Dhaka	+6
RGN	Yangon	+6.5
BKK	Bangkok	+7
HKG	Hong Kong	+8
TYO	Tokyo	+9
ADL	Adelaide	+9.5
SYD	Sydney	+10
NOU	Noumea	+11
WLG	Wellington	+12

- Based on data as of December 2014.
- The rules governing global times (GMT differential and UTC offset) and summer time are determined by each individual country.